

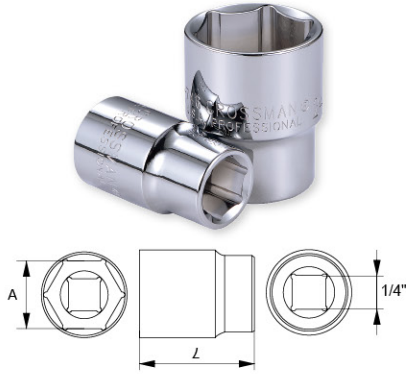

**1/4" Drive**

**1/4" Drive Standard - 6 Point Sockets (Metric)**

Item No.	Size (A)	Length		 kgs
96-113	3.5 mm	25 mm	10/300	0.1/4.2
96-101	4 mm	25 mm	10/300	0.1/4.2
96-110	4.5 mm	25 mm	10/300	0.1/4.2
96-102	5 mm	25 mm	10/300	0.1/4.2
96-111	5.5 mm	25 mm	10/300	0.1/4.3
96-103	6 mm	25 mm	10/300	0.1/4.4
96-104	7 mm	25 mm	10/300	0.1/4.6
96-105	8 mm	25 mm	10/300	0.1/4.7
96-106	9 mm	25 mm	10/300	0.2/5.6
96-107	10 mm	25 mm	10/300	0.2/5.9
96-108	11 mm	25 mm	10/300	0.2/7.7
96-109	12 mm	25 mm	10/300	0.3/8.8
96-112	13 mm	25 mm	10/300	0.3/9.5
96-114	14 mm	25 mm	10/300	0.4/12.0



**1/4" Drive Standard - 6 Point Sockets (SAE)**

Item No.	Size (A)	Length		 kgs
96-021	5/32"	25 mm	10/300	0.1/4.1
96-022	3/16"	25 mm	10/300	0.1/4.3
96-023	7/32"	25 mm	10/300	0.1/4.3
96-024	1/4"	25 mm	10/300	0.1/4.3
96-025	9/32"	25 mm	10/300	0.1/4.6
96-026	5/16"	25 mm	10/300	0.1/4.7
96-027	11/32"	25 mm	10/300	0.2/5.5
96-028	3/8"	25 mm	10/300	0.2/6.1
96-029	7/16"	25 mm	10/300	0.2/7.6
96-030	1/2"	25 mm	10/300	0.3/9.5
96-020	9/16"	25 mm	10/300	0.4/12.0



**1/4" Drive Standard - 12 Point Sockets (Metric)**

Item No.	Size (A)	Length		 kgs
96-050	3.5 mm	25 mm	10/300	0.1/4.2
96-051	4 mm	25 mm	10/300	0.1/4.2
96-052	4.5 mm	25 mm	10/300	0.1/4.2
96-053	5 mm	25 mm	10/300	0.1/4.2
96-054	5.5 mm	25 mm	10/300	0.1/4.3
96-055	6 mm	25 mm	10/300	0.1/4.4
96-056	7 mm	25 mm	10/300	0.1/4.6
96-057	8 mm	25 mm	10/300	0.1/4.7
96-058	9 mm	25 mm	10/300	0.2/5.6
96-059	10 mm	25 mm	10/300	0.2/5.9
96-060	11 mm	25 mm	10/300	0.2/7.7
96-061	12 mm	25 mm	10/300	0.3/8.8
96-062	13 mm	25 mm	10/300	0.3/9.5
96-063	14 mm	25 mm	10/300	0.4/12.0



**1/4" Drive**

**1/4" Drive Standard - 12 Point Sockets (SAE)**

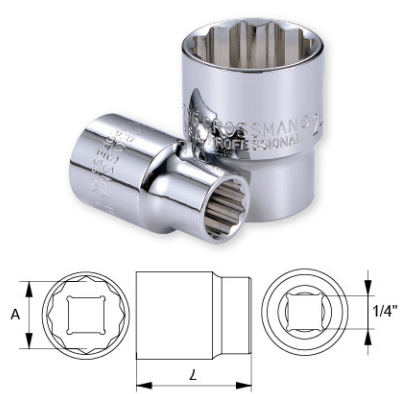

Item No.	Size (A)	Length		 kgs
96-049	5/32"	25 mm	10/300	0.1/4.1
96-045	3/16"	25 mm	10/300	0.1/4.3
96-046	7/32"	25 mm	10/300	0.1/4.3
96-039	1/4"	25 mm	10/300	0.1/4.3
96-047	9/32"	25 mm	10/300	0.1/4.6
96-040	5/16"	25 mm	10/300	0.1/4.7
96-048	11/32"	25 mm	10/300	0.2/5.5
96-041	3/8"	25 mm	10/300	0.2/6.1
96-042	7/16"	25 mm	10/300	0.2/7.6
96-043	1/2"	25 mm	10/300	0.3/9.5
96-044	9/16"	25 mm	10/300	0.4/12.0



**1/4" Drive Deep - 6 Point Sockets (Metric)**



Item No.	Size (A)	Length		 kgs
98-935	4 mm	50 mm	12/312	0.2/6.5
96-179	4.5 mm	50 mm	12/312	0.3/6.9
96-093	5 mm	50 mm	12/312	0.3/7.0
96-361	5.5 mm	50 mm	12/312	0.3/7.2
96-094	6 mm	50 mm	12/312	0.3/7.5
96-195	7 mm	50 mm	12/312	0.3/8.0
96-096	8 mm	50 mm	12/312	0.3/8.2
96-097	9 mm	50 mm	12/312	0.4/10.2
96-098	10 mm	50 mm	12/312	0.4/11.8
96-099	11 mm	50 mm	12/312	0.5/14.4
96-100	12 mm	50 mm	12/312	0.6/16.0
96-116	13 mm	50 mm	12/312	0.7/17.4
96-289	14 mm	50 mm	12/312	0.9/23.2

**1/4" Drive Deep - 6 Point Sockets (SAE)**



Item No.	Size (A)	Length		 kgs
96-031	5/32"	50 mm	12/312	0.2/6.6
96-032	3/16"	50 mm	12/312	0.3/7.0
96-033	7/32"	50 mm	12/312	0.3/7.3
96-034	1/4"	50 mm	12/312	0.3/7.6
96-035	9/32"	50 mm	12/312	0.3/7.8
96-036	5/16"	50 mm	12/312	0.3/7.7
96-037	11/32"	50 mm	12/312	0.4/11.8
96-038	3/8"	50 mm	12/312	0.4/11.1

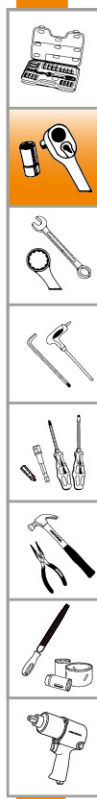

**1/4" Drive**

**1/4" Drive Deep -12 Point Sockets (Metric)**

Item No.	Size (A)	Length		 kgs
98-330	4 mm	50 mm	12/312	0.2/6.5
98-331	4.5 mm	50 mm	12/312	0.3/6.9
98-332	5 mm	50 mm	12/312	0.3/7.0
98-333	5.5 mm	50 mm	12/312	0.3/7.2
98-334	6 mm	50 mm	12/312	0.3/7.5
98-335	7 mm	50 mm	12/312	0.3/8.0
98-336	8 mm	50 mm	12/312	0.3/8.2
98-337	9 mm	50 mm	12/312	0.4/10.2
98-338	10 mm	50 mm	12/312	0.4/11.8
98-339	11 mm	50 mm	12/312	0.5/14.4
98-340	12 mm	50 mm	12/312	0.6/16.0
98-341	13 mm	50 mm	12/312	0.7/17.4
98-342	14 mm	50 mm	12/312	0.9/23.2





**1/4" Drive Deep -12 Point Sockets (SAE)**

Item No.	Size (A)	Length		 kgs
96-181	5/32"	50 mm	12/312	0.2/6.6
96-182	3/16"	50 mm	12/312	0.3/7.0
96-183	7/32"	50 mm	12/312	0.3/7.3
96-184	1/4"	50 mm	12/312	0.3/7.6
96-185	9/32"	50 mm	12/312	0.3/7.8
96-186	5/16"	50 mm	12/312	0.3/7.7
96-187	11/32"	50 mm	12/312	0.4/11.8
96-188	3/8"	50 mm	12/312	0.4/11.1



**1/4" Drive E-Sockets (For TORX<sup>®</sup> Head Screws)**

Item No.	Size (A)	Length		 kgs
93-701	E4	25 mm	10/300	0.1/4.4
93-702	E5	25 mm	10/300	0.1/4.4
93-703	E6	25 mm	10/300	0.1/4.4
93-704	E7	25 mm	10/300	0.1/4.7
93-705	E8	25 mm	10/300	0.2/4.8
93-707	E10	25 mm	10/300	0.2/6.0



**1/4" Drive Phillips Bit Sockets**

Item No.	Size	Length		 kgs
99-401	PH1	37 mm	12/480	0.2/8.1
99-402	PH2	37 mm	12/480	0.2/8.1
99-403	PH3	37 mm	12/480	0.2/8.1



**3/8" Drive**

**3/8" Drive Standard - 6 Point Sockets (Metric)**

Item No.	Size (A)	Length		 kgs
96-301	6 mm	28 mm	10/300	0.3/8.9
96-302	7 mm	28 mm	10/300	0.3/8.9
96-303	8 mm	28 mm	10/300	0.3/8.9
96-304	9 mm	28 mm	10/300	0.3/8.9
96-305	10 mm	28 mm	10/300	0.3/9.0
96-306	11 mm	28 mm	10/300	0.3/9.3
96-307	12 mm	28 mm	10/300	0.3/9.3
96-308	13 mm	28 mm	10/300	0.3/9.7
96-309	14 mm	28 mm	10/200	0.4/8.0
96-310	15 mm	28 mm	10/200	0.5/10.5
96-311	16 mm	28 mm	10/200	0.5/10.5
96-312	17 mm	30 mm	10/200	0.7/13.5
96-313	18 mm	30 mm	10/200	0.7/15.2
96-314	19 mm	30 mm	10/200	0.8/15.7
98-133	20 mm	30 mm	10/200	0.9/18.6
96-316	21 mm	30 mm	10/200	0.9/18.6
96-317	22 mm	30 mm	10/200	1.0/20.4
98-136	23 mm	30 mm	10/200	1.2/23.8
98-137	24 mm	30 mm	10/200	1.2/23.8



**3/8" Drive Standard - 6 Point Sockets (SAE)**

Item No.	Size (A)	Length		 kgs
96-255	1/4"	28 mm	10/300	0.3/8.6
96-256	5/16"	28 mm	10/300	0.3/8.6
98-973	11/32"	28 mm	10/300	0.3/8.9
98-976	3/8"	28 mm	10/300	0.3/8.9
98-977	7/16"	28 mm	10/300	0.3/9.2
98-974	15/32"	28 mm	10/300	0.3/9.2
98-978	1/2"	28 mm	10/300	0.3/9.9
98-979	9/16"	28 mm	10/200	0.4/7.8
98-975	19/32"	28 mm	10/200	0.5/9.6
98-980	5/8"	28 mm	10/200	0.5/9.6
98-161	11/16"	30 mm	10/200	0.6/13.0
98-162	3/4"	30 mm	10/200	0.7/14.5
98-163	25/32"	30 mm	10/200	0.9/18.2
98-164	13/16"	30 mm	10/200	0.9/18.2
98-165	7/8"	30 mm	10/200	1.1/21.6
98-166	15/16"	30 mm	10/200	1.1/23.2



**3/8" Drive**

**3/8" Drive Standard - 12 Point Sockets (Metric)**

Item No.	Size (A)	Length		 kgs
96-342	7 mm	28 mm	10/300	0.3/8.9
96-343	8 mm	28 mm	10/300	0.3/8.9
96-344	9 mm	28 mm	10/300	0.3/8.9
96-345	10 mm	28 mm	10/300	0.3/9.0
96-346	11 mm	28 mm	10/300	0.3/9.3
96-347	12 mm	28 mm	10/300	0.3/9.3
96-348	13 mm	28 mm	10/300	0.3/9.7
96-349	14 mm	28 mm	10/200	0.4/8.0
96-350	15 mm	28 mm	10/200	0.5/10.5
96-351	16 mm	28 mm	10/200	0.5/10.5
96-352	17 mm	30 mm	10/200	0.7/13.5
98-146	18 mm	30 mm	10/200	0.7/15.2
98-147	19 mm	30 mm	10/200	0.8/15.7
98-148	20 mm	30 mm	10/200	0.9/18.6
98-149	21 mm	30 mm	10/200	0.9/18.6
98-150	22 mm	30 mm	10/200	1.0/20.4
98-152	24 mm	30 mm	10/200	1.2/23.8



**3/8" Drive Standard - 12 Point Sockets (SAE)**

Item No.	Size (A)	Length		 kgs
96-260	1/4"	28 mm	10/300	0.3/8.6
96-261	5/16"	28 mm	10/300	0.3/8.6
98-173	11/32"	28 mm	10/300	0.3/8.9
96-262	3/8"	28 mm	10/300	0.3/8.9
96-263	7/16"	28 mm	10/300	0.3/9.2
96-264	1/2"	28 mm	10/300	0.3/9.9
96-265	9/16"	28 mm	10/200	0.4/7.8
96-266	5/8"	28 mm	10/200	0.5/9.6
98-176	11/16"	30 mm	10/200	0.6/13.0
98-177	3/4"	30 mm	10/200	0.7/14.5
98-179	13/16"	30 mm	10/200	0.9/18.2
98-180	7/8"	30 mm	10/200	1.1/21.6

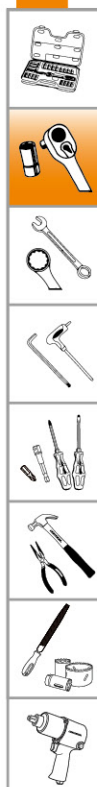

**3/8" Drive**

**3/8" Drive Deep - 6 Point Sockets (Metric)**

Item No.	Size (A)	Length		 kgs
96-320	8 mm	63 mm	12/360	0.7/19.8
96-321	9 mm	63 mm	12/360	0.7/21.7
96-322	10 mm	63 mm	12/360	0.7/22.1
96-323	11 mm	63 mm	12/360	0.8/23.2
96-324	12 mm	63 mm	12/240	0.8/17.3
96-325	13 mm	63 mm	12/240	0.8/17.3
96-326	14 mm	63 mm	12/240	1.0/20
96-327	15 mm	63 mm	12/240	1.3/25
98-825	16 mm	63 mm	12/240	1.3/25
96-328	17 mm	63 mm	12/120	1.5/15
98-326	18 mm	63 mm	12/120	1.9/19
96-329	19 mm	63 mm	12/120	1.9/19
98-328	21 mm	63 mm	12/120	2.0/21



**3/8" Drive Deep - 6 Point Sockets (SAE)**

Item No.	Size (A)	Length		 kgs
98-983	1/4"	63 mm	12/360	0.7/19.8
98-984	5/16"	63 mm	12/360	0.7/21.7
98-985	3/8"	63 mm	12/360	0.7/22.1
98-986	7/16"	63 mm	12/360	0.8/23.2
98-987	1/2"	63 mm	12/240	0.8/16.0
98-988	9/16"	63 mm	12/240	1.0/20.6
98-989	5/8"	63 mm	12/240	1.2/23
98-990	11/16"	63 mm	12/120	1.5/15
98-991	3/4"	63 mm	12/120	1.7/17.3
98-992	13/16"	63 mm	12/120	2.1/21.3



**3/8" Drive Deep - 12 Point Sockets (Metric)**

Item No.	Size (A)	Length		 kgs
96-520	8 mm	63 mm	12/360	0.7/19.8
96-521	9 mm	63 mm	12/360	0.7/21.7
96-522	10 mm	63 mm	12/360	0.7/22.1
96-523	11 mm	63 mm	12/360	0.8/23.2
96-524	12 mm	63 mm	12/240	0.8/17.3
96-525	13 mm	63 mm	12/240	0.8/17.3
96-526	14 mm	63 mm	12/240	1.0/20
96-527	15 mm	63 mm	12/240	1.3/25
98-528	16 mm	63 mm	12/240	1.3/25
96-529	17 mm	63 mm	12/120	1.5/15
98-530	18 mm	63 mm	12/120	1.9/19
96-531	19 mm	63 mm	12/120	1.9/19
98-532	21 mm	63 mm	12/120	2.0/21

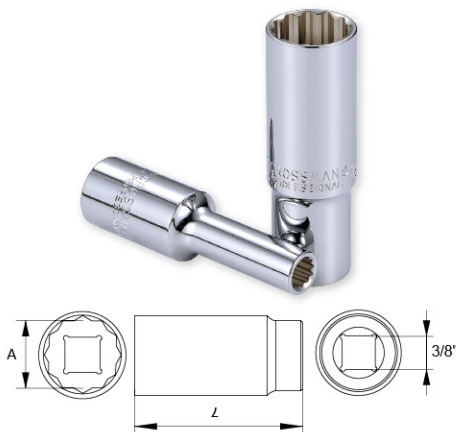

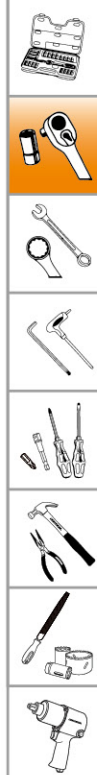



**3/8" Drive**

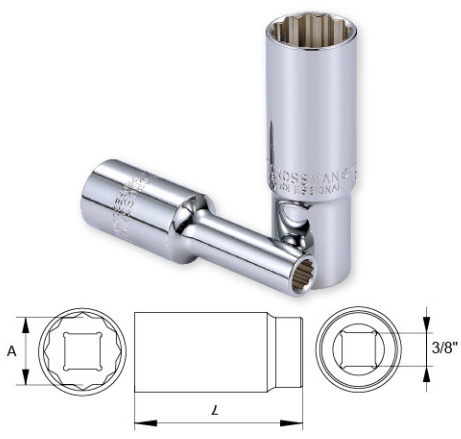

**3/8" Drive Deep - 12 Point Sockets (SAE)**



Item No.	Size (A)	Length		 kgs
98-350	1/4"	63 mm	12/360	0.7/19.8
98-351	5/16"	63 mm	12/360	0.7/21.7
98-352	3/8"	63 mm	12/360	0.7/22.1
98-353	7/16"	63 mm	12/360	0.8/23.2
98-354	1/2"	63 mm	12/240	0.8/16.0
98-355	9/16"	63 mm	12/240	1.0/20.6
98-356	5/8"	63 mm	12/240	1.2/23
98-357	11/16"	63 mm	12/120	1.5/15
98-358	3/4"	63 mm	12/120	1.7/17.3
98-359	13/16"	63 mm	12/120	2.1/21.3



**3/8" Drive Spark Plug Sockets**



Item No.	Size (A)	Length		 kgs
96-380	16 mm (5/8")	65 mm	10/120	1.0/13.0
96-385	18 mm (23/32")	67 mm	10/100	1.3/13.2
96-381	21 mm (13/16")	67 mm	10/100	1.5/15.6



**3/8" Drive Spark Plug Sockets - Magnetic **



Item No.	Size (A)	Length		 kgs
96-382	16 mm (5/8")	65 mm	10/120	1.0/13.0
96-384	18 mm (23/32")	67 mm	10/100	1.3/13.7
98-383	21 mm (13/16")	67 mm	10/100	1.6/16.4



**3/8" Drive E-Sockets (For TORX® Head Screws)**



Item No.	Size (A)	Length		 kgs
99-731	E6	27.5 mm	10/300	0.2/7.0
99-732	E7	27.5 mm	10/300	0.2/5.2
99-733	E8	27.5 mm	10/300	0.3/8.3
99-735	E10	27.5 mm	10/300	0.3/8.8
99-736	E11	27.5 mm	10/300	0.3/8.9
99-737	E12	27.5 mm	10/300	0.3/9.0
99-739	E14	27.5 mm	10/300	0.3/10
99-741	E16	27.5 mm	10/200	0.4/8.8
99-743	E18	28.5 mm	10/200	0.6/11.5
99-745	E20	28.5 mm	10/200	1.1/21.6

**1/2" Drive**

**1/2" Drive Standard - 6 Point Sockets (Metric)**

Item No.	Size (A)	Length		 kgs
96-508	8 mm	38 mm	10/200	0.5/10.5
96-509	9 mm	38 mm	10/200	0.5/10.8
96-510	10 mm	38 mm	10/200	0.5/10.8
96-511	11 mm	38 mm	10/200	0.5/11.2
96-512	12 mm	38 mm	10/200	0.6/11.5
96-513	13 mm	38 mm	10/200	0.5/11.5
96-514	14 mm	38 mm	10/200	0.6/11.9
96-515	15 mm	38 mm	10/200	0.6/12.3
98-738	16 mm	38 mm	10/200	0.6/11.4
98-739	17 mm	38 mm	10/200	0.7/14.5
98-740	18 mm	38 mm	10/200	0.9/18.6
98-741	19 mm	38 mm	10/200	0.8/16.5
98-742	20 mm	38 mm	10/200	1.0/20.4
98-743	21 mm	38 mm	10/200	1.0/19.3
98-744	22 mm	38 mm	10/200	0.9/19.3
98-745	23 mm	38 mm	10/200	1.1/22.6
98-746	24 mm	38 mm	10/200	1.1/21.4
98-747	25 mm	42 mm	10/100	1.4/14.5
98-748	26 mm	42 mm	10/100	1.3/13.6
98-749	27 mm	42 mm	10/100	1.5/15.5
98-750	28 mm	42 mm	10/100	1.5/15.7
98-751	29 mm	42 mm	10/100	1.6/16.9
98-752	30 mm	44 mm	10/100	2.0/20.8
98-754	31 mm	44 mm	10/100	2.0/20.2
98-753	32 mm	44 mm	10/100	2.2/22.8



**1/2" Drive Standard - 6 Point Sockets (SAE)**

Item No.	Size (A)	Length		 kgs
96-441	5/16"	38 mm	10/200	0.5/10.4
96-442	3/8"	38 mm	10/200	0.5/10.7
96-443	7/16"	38 mm	10/200	0.5/10.9
98-777	15/32"	38 mm	10/200	0.5/10.9
96-444	1/2"	38 mm	10/200	0.6/11.6
96-445	9/16"	38 mm	10/200	0.6/11.4
98-778	19/32"	38 mm	10/200	0.6/12.0
98-766	5/8"	38 mm	10/200	0.6/11.6
98-767	11/16"	38 mm	10/200	0.7/14.5
98-779	23/32"	38 mm	10/200	0.9/18.6
98-768	3/4"	38 mm	10/200	0.8/16.4
98-780	25/32"	38 mm	10/200	1.0/20.4
98-769	13/16"	38 mm	10/200	1.0/20.2
98-770	7/8"	38 mm	10/200	0.9/19.0
98-771	15/16"	38 mm	10/200	1.1/23.0
98-773	1"	42 mm	10/100	1.4/14.2
98-774	1-1/16"	42 mm	10/100	1.5/14.9
96-458	1-1/8"	42 mm	10/100	1.6/16.5
98-775	1-3/16"	44 mm	10/100	1.8/18.9
98-776	1-1/4"	44 mm	10/100	2.0/21.0





**Hand Sockets**



**1/2" Drive**

**1/2" Drive Standard - 12 Point Sockets (Metric)**

Item No.	Size (A)	Length		 kgs
96-540	8 mm	38 mm	10/200	0.5/10.4
96-541	9 mm	38 mm	10/200	0.5/10.4
96-542	10 mm	38 mm	10/200	0.5/10.5
96-543	11 mm	38 mm	10/200	0.5/10.9
96-544	12 mm	38 mm	10/200	0.5/11.2
96-545	13 mm	38 mm	10/200	0.6/11.5
96-546	14 mm	38 mm	10/200	0.6/11.9
96-547	15 mm	38 mm	10/200	0.6/11.9
98-788	16 mm	38 mm	10/200	0.5/11.0
98-789	17 mm	38 mm	10/200	0.7/14.5
98-790	18 mm	38 mm	10/200	0.9/18.6
98-791	19 mm	38 mm	10/200	0.8/15.4
98-792	20 mm	38 mm	10/200	1.0/20.4
98-793	21 mm	38 mm	10/200	0.9/18.5
98-794	22 mm	38 mm	10/200	0.9/18.0
98-795	23 mm	38 mm	10/200	1.1/21.7
98-796	24 mm	38 mm	10/200	1.0/19.9
98-797	25 mm	42 mm	10/100	1.3/13.7
98-798	26 mm	42 mm	10/100	1.3/13.1
98-799	27 mm	42 mm	10/100	1.4/14.7
98-800	28 mm	42 mm	10/100	1.6/16.9
98-801	29 mm	42 mm	10/100	1.6/16.1
98-802	30 mm	44 mm	10/100	1.8/18.9
98-804	31 mm	44 mm	10/100	2.0/21.0
98-803	32 mm	44 mm	10/100	2.4/24.0





**1/2" Drive Standard - 12 Point Sockets (SAE)**

Item No.	Size (A)	Length		 kgs
96-460	5/16"	38 mm	10/200	0.5/10.9
96-461	3/8"	38 mm	10/200	0.5/10.4
96-462	7/16"	38 mm	10/200	0.5/10.6
96-463	1/2"	38 mm	10/200	0.6/11.5
96-464	9/16"	38 mm	10/200	0.5/11.1
98-815	5/8"	38 mm	10/200	0.5/11.1
98-816	11/16"	38 mm	10/200	0.7/14.5
98-817	3/4"	38 mm	10/200	0.8/15.6
98-818	13/16"	38 mm	10/200	0.9/19.0
98-819	7/8"	38 mm	10/200	0.9/17.8
98-820	15/16"	38 mm	10/200	1.0/21.3
98-821	1"	42 mm	10/100	1.4/14.0
98-822	1-1/16"	42 mm	10/100	1.4/14.4
96-496	1-1/8"	42 mm	10/100	1.5/15.8
98-823	1-3/16"	44 mm	10/100	1.9/19.3
98-824	1-1/4"	44 mm	10/100	2.0/20.8



**1/2" Drive**

**1/2" Drive Deep - 6 Point Sockets (Metric)**

Item No.	Size (A)	Length		 kgs
96-416	8 mm	77 mm	12/144	1.5/18.3
96-417	9 mm	77 mm	12/144	1.3/15.8
96-418	10 mm	77 mm	12/144	1.3/16.2
96-419	11 mm	77 mm	12/144	1.3/15.5
96-420	12 mm	77 mm	12/144	1.4/17.2
96-421	13 mm	77 mm	12/144	1.5/17.9
96-422	14 mm	77 mm	12/144	1.4/17.5
96-423	15 mm	77 mm	12/144	1.4/17.7
96-424	16 mm	77 mm	12/144	1.4/16.9
96-425	17 mm	77 mm	12/120	1.8/18.3
96-426	18 mm	77 mm	12/120	2.2/22.6
96-427	19 mm	77 mm	12/120	2.0/20.3
96-428	20 mm	77 mm	12/120	2.5/25.0
96-429	21 mm	77 mm	12/120	2.2/22.6
96-430	22 mm	77 mm	12/72	2.8/17.1
96-431	23 mm	77 mm	12/72	3.2/19.7
96-432	24 mm	77 mm	12/72	3.2/19.5
96-433	25 mm	77 mm	12/72	3.6/22.1
96-434	26 mm	77 mm	12/72	3.5/21.6
96-435	27 mm	77 mm	12/48	4.0/16.5
96-436	28 mm	77 mm	12/48	4.7/19.2
96-438	30 mm	77 mm	12/48	4.6/18.8
96-439	32 mm	77 mm	12/48	5.7/23.1





**1/2" Drive Deep - 6 Point Sockets (SAE)**

Item No.	Size (A)	Length		 kgs
96-479	3/8"	77 mm	12/144	1.3/16.2
96-480	7/16"	77 mm	12/144	1.3/15.5
96-481	1/2"	77 mm	12/144	1.5/17.9
96-482	9/16"	77 mm	12/144	1.5/17.8
96-483	5/8"	77 mm	12/144	1.5/17.8
96-484	11/16"	77 mm	12/120	1.6/16.0
96-485	3/4"	77 mm	12/120	2.0/20.6
96-486	13/16"	77 mm	12/120	2.2/22.6
96-487	7/8"	77 mm	12/72	2.8/17.1
96-488	15/16"	77 mm	12/72	3.2/19.5
96-489	1"	77 mm	12/72	3.6/22.1
96-490	1-1/16"	77 mm	12/48	4.0/16.5
96-491	1-1/8"	77 mm	12/48	4.6/18.8
96-497	1-1/4"	77 mm	12/48	5.7/23.1



**1/2" Drive**

**1/2" Drive Deep - 12 Point Sockets (Metric)**

Item No.	Size (A)	Length		 kgs
96-716	8 mm	77 mm	12/144	1.5/18.3
96-717	9 mm	77 mm	12/144	1.3/15.8
96-718	10 mm	77 mm	12/144	1.3/16.2
96-719	11 mm	77 mm	12/144	1.3/15.5
96-720	12 mm	77 mm	12/144	1.4/17.2
96-721	13 mm	77 mm	12/144	1.5/17.9
96-722	14 mm	77 mm	12/144	1.4/17.5
96-723	15 mm	77 mm	12/144	1.4/17.7
96-724	16 mm	77 mm	12/144	1.4/16.9
96-725	17 mm	77 mm	12/120	1.8/18.3
96-726	18 mm	77 mm	12/120	2.2/22.6
96-727	19 mm	77 mm	12/120	2.0/20.3
96-728	20 mm	77 mm	12/120	2.5/25.0
96-729	21 mm	77 mm	12/120	2.2/22.6
96-730	22 mm	77 mm	12/72	2.8/17.1
96-731	23 mm	77 mm	12/72	3.2/19.7
96-732	24 mm	77 mm	12/72	3.2/19.5
96-735	27 mm	77 mm	12/48	4.2/16.5
96-738	30 mm	77 mm	12/48	4.6/18.8
96-739	32 mm	77 mm	12/48	5.7/23.1



**1/2" Drive Deep - 12 Point Sockets (SAE)**

Item No.	Size (A)	Length		 kgs
96-550	3/8"	77 mm	12/144	1.3/16.2
96-551	7/16"	77 mm	12/144	1.3/15.5
96-552	1/2"	77 mm	12/144	1.5/17.9
96-553	9/16"	77 mm	12/144	1.5/17.8
96-554	5/8"	77 mm	12/144	1.5/17.8
96-555	11/16"	77 mm	12/120	1.6/16.0
96-556	3/4"	77 mm	12/120	2.0/20.6
96-557	13/16"	77 mm	12/120	2.2/22.6
96-558	7/8"	77 mm	12/72	2.8/17.1
96-559	15/16"	77 mm	12/72	3.2/19.5
96-560	1"	77 mm	12/72	3.6/22.1
96-561	1-1/16"	77 mm	12/48	4.0/16.5
96-562	1-1/8"	77 mm	12/48	4.6/18.8
96-563	1-1/4"	77 mm	12/48	5.7/23.1



**1/2" Drive**

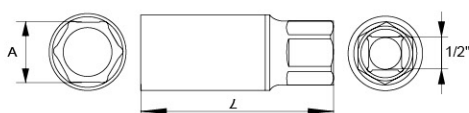

■ **1/2" Drive Spark Plug Sockets**

Item No.	Size (A)	Length		kgs
96-580	16 mm (5/8")	65 mm	10/100	1.0/10.3
96-585	18 mm (23/32")	67 mm	10/100	1.5/15.0
96-581	21 mm (13/16")	67 mm	10/100	1.5/15.4

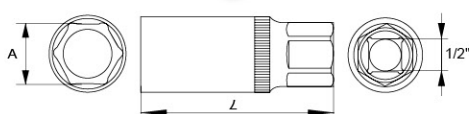

■ **1/2" Drive Spark Plug Sockets-Magnetic**

Item No.	Size (A)	Length		kgs
96-582	16 mm (5/8")	65 mm	10/100	1.1/11.7
96-584	18 mm (23/32")	67 mm	10/100	1.5/15.0
96-583	21 mm (13/16")	67 mm	10/100	1.6/15.9

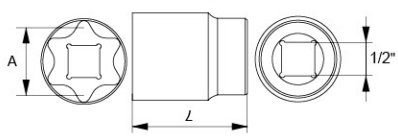

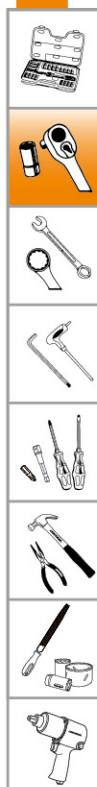

■ **1/2" Drive E-Sockets (For TORX<sup>®</sup> Head Screws)**

Item No.	Size (A)	Length		kgs
93-503	E10	38 mm	10/200	0.5/10.9
93-504	E11	38 mm	10/200	0.5/10.9
93-505	E12	38 mm	10/200	0.5/11.2
93-507	E14	38 mm	10/200	0.5/11.2
93-509	E16	38 mm	10/200	0.6/11.5
93-511	E18	38 mm	10/200	0.7/14.7
93-513	E20	38 mm	10/200	0.7/14.9
93-515	E22	38 mm	10/200	0.8/17.0
93-517	E24	38 mm	10/200	1.1/21.6



**3/4" Drive**

**Extensions**

Item No.	Size (L)		 kgs
99-306	4"	6/36	2.6/16.2
99-309	6"	6/24	3.9/16.1
99-307	8"	6/24	5.0/20.2
99-308	16"	3/12	4.8/19.8

**Quick Release Extensions**

Item No.	Size (L)		 kgs
99-356	4"	6/36	2.8/16.9
99-357	8"	6/24	5.2/21.1
99-358	16"	3/12	4.8/20.0

**Socket Drive Adapter**

Item No.	Size		 kgs
99-909	3/4"F x 1/2"M	6/36	1.2/7.8

**Universal Joint**

Item No.	Size (L)		 kgs
99-911	4"	6/36	3.4/21.0

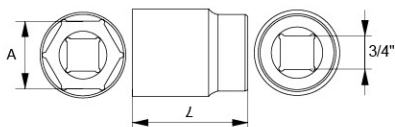

**3/4" Drive Standard - 6 Point Sockets (Metric)**

Item No.	Size (A)	Length		 kgs
99-317	17 mm	50 mm	10/80	1.9/15.4
99-319	19 mm	50 mm	10/80	1.9/15.4
99-321	21 mm	50 mm	10/80	1.9/15.4
99-322	22 mm	50 mm	10/80	2.2/18.3
99-323	23 mm	50 mm	10/80	2.2/18.4
99-324	24 mm	51 mm	10/80	2.3/19.0
99-325	25 mm	52 mm	10/80	2.4/19.6
99-326	26 mm	52 mm	10/80	2.6/21.3
99-327	27 mm	52 mm	10/80	2.6/21.3
99-328	28 mm	52 mm	10/80	2.7/22.1
99-329	29 mm	54 mm	6/36	1.6/10.0
99-330	30 mm	56 mm	6/36	1.8/11.0
99-331	31 mm	56 mm	6/36	2.0/12.6
99-332	32 mm	56 mm	6/36	2.0/12.6
99-333	33 mm	56 mm	6/36	2.1/13.0
99-334	34 mm	56 mm	6/36	2.1/13.0
99-335	35 mm	58 mm	6/36	2.5/15.6
99-336	36 mm	58 mm	6/36	2.6/16.2
99-337	37 mm	58 mm	6/36	3.1/19.1
99-338	38 mm	60 mm	6/36	3.1/19.1
99-339	39 mm	62 mm	24	12.9
99-340	40 mm	62 mm	24	12.9





**3/4" Drive**

**3/4" Drive Standard - 6 Point Sockets (Metric)**

Item No.	Size (A)	Length		 kgs
99-341	41 mm	64 mm	24	13.9
99-342	42 mm	64 mm	24	14.2
99-343	43 mm	65 mm	24	14.8
99-344	44 mm	66 mm	24	15.9
99-345	45 mm	66 mm	24	15.9
99-346	46 mm	68 mm	20	14.4
99-347	47 mm	70 mm	20	15.2
99-348	48 mm	70 mm	20	15.2
99-350	50 mm	72 mm	20	17.2
99-354	54 mm	72 mm	12	11.1
99-355	55 mm	76 mm	12	11.9
99-256	56 mm	76 mm	12	12.9
99-360	60 mm	78 mm	12	13.4
99-363	63 mm	80 mm	8	10.3
99-365	65 mm	82 mm	8	12.1





**3/4" Drive Standard - 6 Point Sockets (SAE)**

Item No.	Size (A)	Length		 kgs
99-661	3/4"	50 mm	10/80	2.1/17.6
99-662	13/16"	50 mm	10/80	2.1/17.6
99-663	7/8"	50 mm	10/80	2.2/18.3
99-664	15/16"	51 mm	10/80	2.2/18.4
99-665	1"	52 mm	10/80	2.3/19.0
99-666	1-1/16"	52 mm	10/80	2.3/19.0
99-667	1-1/8"	52 mm	6/36	1.6/10.1
99-668	1-3/16"	54 mm	6/36	1.8/11.0
99-669	1-1/4"	56 mm	6/36	1.9/11.6
99-670	1-5/16"	56 mm	6/36	2.1/12.7
99-671	1-3/8"	58 mm	6/36	2.4/15.0
99-672	1-7/16"	60 mm	6/36	2.6/15.9
99-673	1-1/2"	60 mm	6/36	2.8/17.4
99-680	1-9/16"	62 mm	24	12.9
99-674	1-5/8"	64 mm	24	13.5
99-675	1-11/16"	64 mm	24	14.1
99-676	1-3/4"	66 mm	24	16.4
99-677	1-13/16"	68 mm	20	14.7
99-678	1-7/8"	70 mm	20	14.7
99-679	2"	72 mm	20	16.2
98-960	2-1/4"	76 mm	12	11.6
98-961	2-3/8"	78 mm	8	9.2
98-962	2-1/2"	80 mm	8	10.3
98-963	2-3/4"	86 mm	4	7.1



**3/4" Drive**

**3/4" Drive Standard - 12 Point Sockets (Metric)**

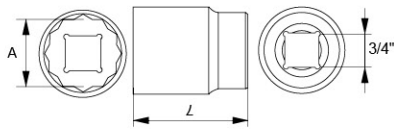

Item No.	Size (A)	Length	 	 kgs
93-317	17 mm	50 mm	10/80	1.9/15.4
93-319	19 mm	50 mm	10/80	1.9/15.4
93-321	21 mm	50 mm	10/80	1.9/15.4
93-322	22 mm	50 mm	10/80	2.2/18.3
93-323	23 mm	50 mm	10/80	2.2/18.4
93-324	24 mm	51 mm	10/80	2.3/19.0
93-325	25 mm	52 mm	10/80	2.4/19.6
93-326	26 mm	52 mm	10/80	2.6/21.3
93-327	27 mm	52 mm	10/80	2.6/21.3
93-328	28 mm	52 mm	10/80	2.7/22.1
93-329	29 mm	52 mm	6/36	1.6/10.0
93-330	30 mm	54 mm	6/36	1.8/11.0
93-331	31 mm	54 mm	6/36	2.0/12.6
93-332	32 mm	56 mm	6/36	2.0/12.6
93-333	33 mm	56 mm	6/36	2.0/12.6
93-334	34 mm	56 mm	6/36	2.1/13.0
93-335	35 mm	58 mm	6/36	2.1/13.0
93-336	36 mm	58 mm	6/36	2.5/15.6
93-337	37 mm	60 mm	6/36	2.6/16.2
93-338	38 mm	60 mm	6/36	2.6/16.2
93-339	39 mm	62 mm	6/36	3.2/16.0
93-340	40 mm	62 mm	6/36	13.9
93-341	41 mm	62 mm	24	13.9
93-343	43 mm	62 mm	24	14.1
93-344	44 mm	62 mm	24	14.6
93-345	45 mm	62 mm	24	14.4
93-346	46 mm	70 mm	20	14.4
93-347	47 mm	70 mm	20	15.0
93-350	50 mm	72 mm	20	17.2
93-354	54 mm	72 mm	12	11.1
93-355	55 mm	76 mm	12	11.9
93-356	56 mm	76 mm	12	12.9
93-360	60 mm	78 mm	12	13.4
93-363	63 mm	80 mm	8	10.3
93-365	65 mm	82 mm	8	12.1



**3/4" Drive**

**3/4" Drive Standard - 12 Point Sockets (SAE)**



Item No.	Size (A)	Length		 kgs
93-661	3/4"	50 mm	10/80	2.1/17.6
93-662	13/16"	50 mm	10/80	2.1/17.6
93-663	7/8"	50 mm	10/80	2.2/18.3
93-664	15/16"	51 mm	10/80	2.2/18.4
93-665	1"	52 mm	10/80	2.3/19.0
93-666	1-1/16"	52 mm	10/80	2.3/19.0
93-667	1-1/8"	52 mm	6/36	1.6/10.1
93-668	1-3/16"	54 mm	6/36	1.8/11.0
93-669	1-1/4"	56 mm	6/36	1.9/11.6
93-670	1-5/16"	56 mm	6/36	2.1/12.7
93-671	1-3/8"	58 mm	6/36	2.4/15.0
93-672	1-7/16"	60 mm	6/36	2.6/15.9
93-673	1-1/2"	60 mm	6/36	2.8/17.4
93-680	1-9/16"	62 mm	24	12.9
93-674	1-5/8"	64 mm	24	13.5
93-675	1-11/16"	64 mm	24	14.1
93-676	1-3/4"	66 mm	24	16.4
93-677	1-13/16"	68 mm	20	14.7
93-678	1-7/8"	70 mm	20	14.7
93-679	2"	72 mm	20	16.2
93-681	2-1/4"	76 mm	12	11.6
93-682	2-3/8"	78 mm	8	9.2
93-683	2-1/2"	80 mm	8	10.3
93-684	2-3/4"	87 mm	4	7.1

