





Wrenches



■ Single Open End Spanner (Metric)

Item No.	Size	Length	 
92-501	17 mm	178 mm	12/120
92-502	19 mm	178 mm	12/120
92-504	21 mm	203 mm	12/120
92-505	22 mm	203 mm	12/120
92-506	23 mm	220 mm	12/96
92-507	24 mm	220 mm	12/96
92-508	26 mm	240 mm	6/60
92-509	27 mm	240 mm	6/60
92-510	29 mm	267 mm	6/60
92-511	30 mm	267 mm	6/60
92-512	32 mm	285 mm	4/32
92-513	34 mm	317 mm	4/32
92-514	35 mm	317 mm	4/32
92-515	36 mm	317 mm	4/32
92-516	38 mm	320 mm	2/20
92-517	41 mm	340 mm	2/20
92-518	46 mm	395 mm	2/20
92-519	50 mm	425 mm	2/16
92-520	55 mm	425 mm	2/16
92-521	60 mm	470 mm	1/8
92-522	65 mm	470 mm	1/8
92-523	70 mm	500 mm	1/6
92-524	75 mm	500 mm	1/6



Wrenches

■ Box End Podger Spanner, 45 Degree Offset (Metric)

Item No.	Size	Length	 
92-530	17 mm	335 mm	6/60
92-531	19 mm	335 mm	6/60
92-532	22 mm	354 mm	6/48
92-534	24 mm	388 mm	4/32
92-535	26 mm	388 mm	4/32
92-536	27 mm	406 mm	4/32
92-537	29 mm	393 mm	4/32
92-538	30 mm	414 mm	4/24
92-539	32 mm	414 mm	4/24
92-540	36 mm	476 mm	2/16
92-541	41 mm	532 mm	2/8
92-542	46 mm	532 mm	2/8
92-543	50 mm	553 mm	2/8
92-544	55 mm	610 mm	1/6
92-545	58 mm	610 mm	1/6
92-546	60 mm	610 mm	1/6

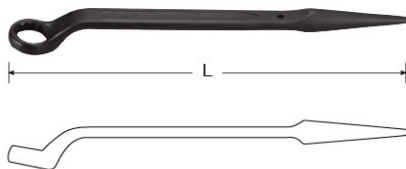



Wrenches

■ Box End Slogging Spanner (Metric)

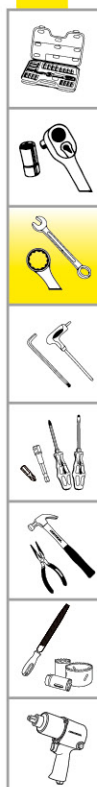

Item No.	Size	Length	
92-701	27 mm	190 mm	6/48
92-702	30 mm	190 mm	6/48
92-703	32 mm	190 mm	6/48
92-704	34 mm	206 mm	4/32
92-705	36 mm	206 mm	4/32
92-706	38 mm	206 mm	4/32
92-707	41 mm	240 mm	2/20
92-708	42 mm	240 mm	2/20
92-709	46 mm	240 mm	2/20
92-710	50 mm	255 mm	2/16
92-711	55 mm	270 mm	1/12
92-712	60 mm	300 mm	1/10
92-713	65 mm	330 mm	1/6
92-714	70 mm	330 mm	1/6
92-715	75 mm	330 mm	1/6
92-716	80 mm	360 mm	1/4
92-717	85 mm	360 mm	1/4
92-718	90 mm	400 mm	1/4
92-719	95 mm	400 mm	1/4
92-720	100 mm	400 mm	1/4
92-721	105 mm	435 mm	1/2
92-722	110 mm	435 mm	1/2
92-723	115 mm	435 mm	1/2
92-724	120 mm	480 mm	1/2
92-725	125 mm	480 mm	1/2





Wrenches

Box End Slogging Spanner (SAE)

Item No.	Size	Length	 
92-730	1-1/16"	190 mm	6/48
92-731	1-1/8"	190 mm	6/48
92-732	1-3/16"	190 mm	6/48
92-733	1-1/4"	190 mm	6/48
92-734	1-5/16"	206 mm	4/32
92-735	1-3/8"	206 mm	4/32
92-736	1-7/16"	206 mm	4/32
92-737	1-1/2"	206 mm	4/32
92-738	1-9/16"	240 mm	2/20
92-739	1-5/8"	240 mm	2/20
92-740	1-11/16"	240 mm	2/20
92-741	1-3/4"	240 mm	2/20
92-742	1-13/16"	240 mm	2/20
92-743	1-7/8"	240 mm	2/20
92-744	1-15/16"	255 mm	2/16
92-745	2"	255 mm	2/16
92-746	2-1/16"	255 mm	2/16
92-747	2-1/8"	255 mm	2/16
92-748	2-3/16"	270 mm	1/12
92-749	2-1/4"	270 mm	1/12
92-750	2-5/16"	270 mm	1/12
92-751	2-3/8"	300 mm	1/10
92-752	2-7/16"	300 mm	1/10
92-753	2-1/2"	300 mm	1/10
92-754	2-9/16"	300 mm	1/10
92-755	2-5/8"	300 mm	1/10
92-756	2-11/16"	300 mm	1/10
92-757	2-3/4"	330 mm	1/6
92-758	2-13/16"	330 mm	1/6
92-759	2-7/8"	330 mm	1/6
92-760	2-15/16"	330 mm	1/6
92-761	3"	330 mm	1/6
92-762	3-1/16"	330 mm	1/6
92-763	3-1/8"	330 mm	1/6
92-764	3-1/4"	360 mm	1/4
92-765	3-3/8"	360 mm	1/4
92-766	3-1/2"	360 mm	1/4
92-767	3-5/8"	400 mm	1/4
92-768	3-3/4"	400 mm	1/4
92-769	3-7/8"	400 mm	1/4
92-770	4"	400 mm	1/4
92-771	4-1/8"	435 mm	1/2
92-772	4-1/4"	435 mm	1/2
92-773	4-1/2"	435 mm	1/2
92-774	4-3/4"	480 mm	1/2
92-775	5"	480 mm	1/2
92-776	5-1/8"	480 mm	1/2







Wrenches



■ Box End Slogging Spanner, 45 Degree Offset (Metric)

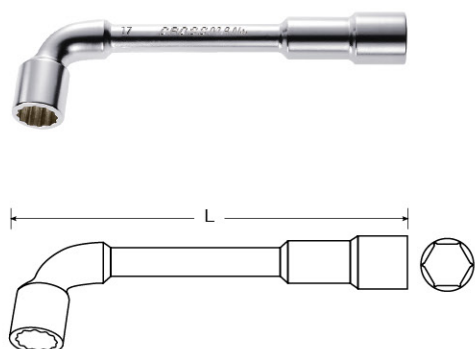

Item No.	Size	Length	 
92-780	24 mm	250 mm	10/10
92-781	27 mm	250 mm	10/10
92-782	30 mm	270 mm	10/10
92-783	32 mm	270 mm	10/10
92-784	36 mm	300 mm	10/10
92-785	38 mm	300 mm	10/10
92-786	41 mm	317 mm	5/5
92-787	43 mm	317 mm	5/5
92-788	46 mm	360 mm	5/5
92-789	50 mm	360 mm	5/5
92-790	55 mm	360 mm	5/5
92-791	60 mm	360 mm	5/5
92-792	65 mm	380 mm	2/2
92-793	70 mm	380 mm	2/2
92-794	75 mm	420 mm	2/2
92-795	80 mm	420 mm	2/2
92-796	85 mm	450 mm	2/2
92-797	90 mm	450 mm	2/2
92-798	95 mm	500 mm	1/1
92-799	100 mm	500 mm	1/1
92-800	105 mm	515 mm	1/1
92-801	110 mm	515 mm	1/1
92-802	115 mm	515 mm	1/1

■ Angle Pipe Wrench - 12 Point x 6 Point (Metric)



Item No.	Size	Length	 
92-670	M6	100 mm	12/240
92-671	M7	100 mm	12/240
92-672	M8	120 mm	12/240
92-673	M9	120 mm	12/240
92-674	M10	127 mm	12/120
92-675	M11	127 mm	12/120
92-676	M12	135 mm	12/120
92-677	M13	140 mm	12/120
92-678	M14	154 mm	6/72
92-679	M15	160 mm	6/72
92-680	M16	185 mm	6/48
92-681	M17	185 mm	6/48
92-682	M18	195 mm	6/48
92-683	M19	195 mm	6/48
92-684	M20	205 mm	2/36
92-685	M21	205 mm	2/36
92-686	M22	225 mm	2/36
92-687	M23	225 mm	2/24
92-688	M24	225 mm	2/24
92-689	M25	225 mm	2/24
92-690	M26	260 mm	1/12
92-691	M27	260 mm	1/12
92-692	M28	270 mm	1/12
92-693	M29	275 mm	1/12
92-694	M30	295 mm	1/12
92-695	M32	305 mm	1/12

